

Product Overview

The QPL8831 is an ultra-linear GaAs pHEMT 75-Ohm RF balanced amplifier IC with 5 – 1218 MHz operating bandwidth, featuring high linearity, high gain and low noise for use as a post amplifier in optical receivers or as a low noise balanced preamp. This IC uses a 5V supply for applications requiring lower power dissipation. Due to its wide operational bandwidth the QPL8831 can also be used as a downstream amp in DOCSIS 3.1 as well as an upstream amplifier for DOCSIS 3.1 or DOCSIS 4.0 applications.



8-Pin SOIC Package

Functional Block Diagram

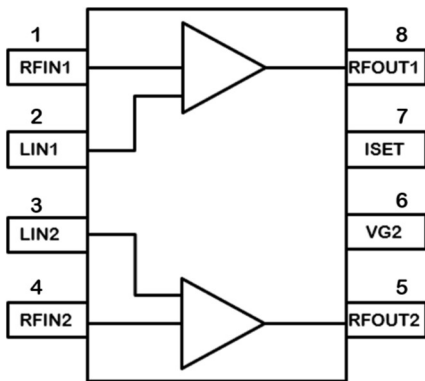

Key Features

- High Gain: 17dB at 1218 MHz
- 5– 1218 MHz BW
- OIP3: +43 dBm, Downstream 50– 1218 MHz
- OP1dB: 24 dBm, Downstream 50– 1218 MHz
- Low Noise Figure: 4 dB, Full Band
- Excellent Composite Distortion
- pHEMT GaAs device technologies
- Compact Size: 8-pin SOIC
- Power Consumption (5 V, 280 mA, 1.4 W)

Applications

- DOCSIS 3.1 Systems
- Balanced Antenna Applications
- HFC Optical Nodes
- 75 Ω Amplifiers
- Upstream Amplifier for DOCSIS 3.1 and DOCSIS 4.0 Applications

Ordering Information

| Part Number | Description |
|---------------|---------------------------------------|
| QPL8831SB | Sample bag with 5 pieces |
| QPL8831SR | 7" Reel with 100 pieces |
| QPL8831TR13 | 13" Reel with 2500 pieces |
| QPL8831PCK-01 | 5– 1218 MHz PCBA with 5 pc sample bag |

Absolute Maximum Ratings

| Parameter | Rating |
|-----------------------------------|----------------|
| Supply Voltage (V_{DD}) | +8 V |
| Supply Current (I_{DD}) | 400 mA |
| Maximum Input Level (single tone) | +15 dBm |
| Operating Temperature Range | -40 to +85 °C |
| Storage Temperature Range | -40 to +150 °C |
| Maximum Junction Temperature | +150 °C |

Exceeding any one or a combination of the Absolute Maximum Rating conditions may cause permanent damage to the device. Extended application of Absolute Maximum Rating conditions to the device may reduce device reliability.

Electrical Specifications

| Parameter | Condition ⁽¹⁾ | Min | Typ | Max | Unit |
|-----------------------------|---|-----|------|------|------|
| Supply Voltage (V_{DD}) | | | 5 | | V |
| Supply Current (I_{DD}) | V_{DD} total current | | 280 | | mA |
| Frequency Range | | 5 | | 1218 | MHz |
| Gain | 5 – 1218 MHz | | 17 | | dB |
| Gain Flatness | 5 – 1218 MHz | | ±0.5 | | dB |
| Input Return Loss | 5 – 1218 MHz | | 18 | | dB |
| Output Return Loss | 5 – 1218 MHz | | 18 | | dB |
| Noise Figure | 5 – 1218 MHz | | 4 | | dB |
| CSO | 80 Ch NTSC + 111 QAM, flat tilt, 43dBmV / Ch downstream | | -69 | | dBc |
| CTB | | | -71 | | dBc |
| CIN | | | 63 | | dB |
| OIP2 | 13 dBm / tone, $\Delta f = 50$ MHz, 50-1218 MHz | | 70 | | dBm |
| OIP3 | 13 dBm / tone, $\Delta f = 6$ MHz, 50-1218 MHz | | 43 | | dBm |
| OIP2 | 13 dBm / tone, $\Delta f = 50$ MHz, 5-700 MHz | | 71 | | dBm |
| OIP3 | 13 dBm / tone, $\Delta f = 6$ MHz, 5-700 MHz | | 45 | | dBm |
| Output P1dB | 50 – 1218 MHz | | 24 | | dBm |
| Output P1dB | 5 – 700 MHz | | 25 | | dBm |
| Thermal Resistance | | | 13 | | °C/W |

Notes:

1. Typical performance at these conditions: Temp = +25 °C, $V_{DD} = +5$ V, 75 Ω system, Full band unless otherwise noted.
2. Downstream (Forward Path) Freq Range is 50-1218 MHz.
3. Upstream (Return Path) Freq Range is 5-700 MHz.

Evaluation Board Schematic

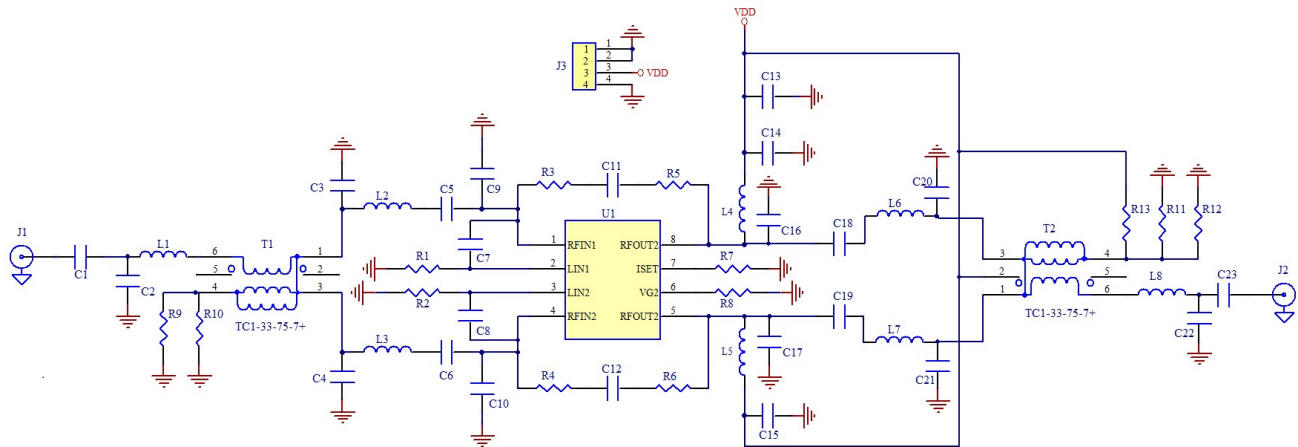

Bill of Material for Evaluation Board

| Reference Designator | Description | Manufacturer | Part Number |
|--|-------------------------------------|-----------------|--------------------|
| U1 | 1218 MHz, 17 dB Push-Pull Amp | Qorvo | QPL8831SB |
| PCB | EVB PCB, QPL8831 | Qorvo | QPL883x-4001 |
| C22 | CAP, 0.2 pF, +/-0.05 pF, 50 V, 0402 | Johanson | 500R07S0R2AV4T |
| C1, C5, C6, C7, C8, C11, C12, C13, C14, C15, C23 | CAP, 0.01uF, 10 %, 50 V, 0402 | Murata | GCM155R71H103KA55D |
| C18, C19 | CAP, 270 pF, 5 %, 0402 | Murata | GCM1555C1H271JA16D |
| R5, R6, R9, R11, L1, L2, L3, L6, L7 | RES, 0 Ω, 0402 | Kamaya | RMC1/16SJPTH |
| R7 | RES, 1.5 KΩ, 5 %, 1/16 W, 0402 | Kamaya | RMC1/16S-152JTH |
| R8 | RES, 3.9 KΩ, 5 %, 1/16 W, 0402 | Kamaya | RMC1/16S-392JTH |
| R3, R4 | RES, 470 Ω, 5 %, 1/16 W, 0402 | Kamaya | RMC1/16S-471JTH |
| R1, R2 | RES, 1.2 KΩ, 5 %, 1/16 W, 0402 | Kamaya | RMC1/16S-122JTH |
| L8 | IND, 1.6nH, +/-0.1 nH, 0402 | Murata | LQG15HS1N6B02D |
| L4, L5 | IND, 560 nH, 5 %, 0603 | Coilcraft | 0603LS-561XJLB |
| T1, T2 | TRANSFORMER, 1:1 | Mini Circuits | TC1-33-75-7+ |
| J3 | CONN, HDR | Samtec | TSW-103-07-G-S |
| J1, J2 | CONN, F FEM, 75OHM | Millimeter Wave | MW-846-C-DD-75 |
| C2, C3, C4, C9, C10, C16, C17, C20, C21, R10, R12, R13 | DNP | | |

Simplified Application Schematic for Downstream (50 – 1218 MHz)

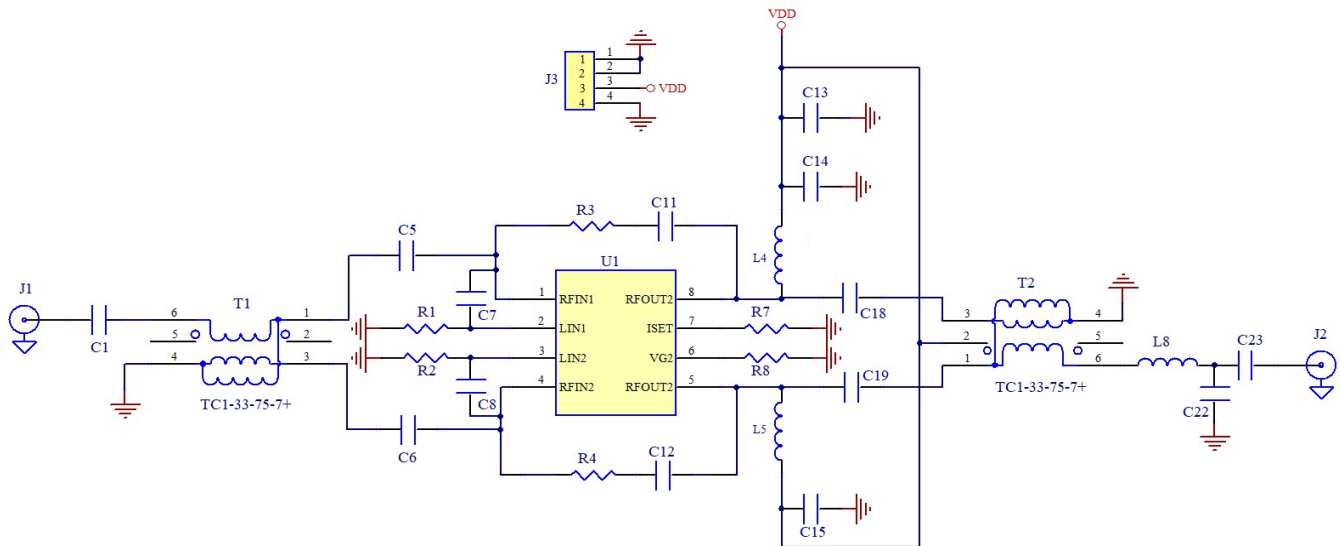

Bill of Material for Simplified Application: Downstream (50 – 1218 MHz)

| Reference Designator | Description | Manufacturer | Part Number |
|--|-------------------------------------|-----------------|--------------------|
| U1 | 1218 MHz, 17 dB Push-Pull Amp | Qorvo | QPL8831SB |
| PCB | EVB PCB, QPL8831 | Qorvo | QPL883x-4001 |
| C22 | CAP, 0.2 pF, +/-0.05 pF, 50 V, 0402 | Johanson | 500R07S0R2AV4T |
| C1, C5, C6, C7, C8, C11, C12, C13, C14, C15, C23 | CAP, 0.01 uF, 10 %, 50 V, 0402 | Murata | GCM155R71H103KA55D |
| C18, C19 | CAP, 270 pF, 5 %, 0402 | Murata | GCM1555C1H271JA16D |
| R7 | RES, 1.5 KΩ, 5 %, 1/16 W, 0402 | Kamaya | RMC1/16S-152JTH |
| R8 | RES, 3.9 KΩ, 5 %, 1/16 W, 0402 | Kamaya | RMC1/16S-392JTH |
| R3, R4 | RES, 470 Ω, 5 %, 1/16 W, 0402 | Kamaya | RMC1/16S-471JTH |
| R1, R2 | RES, 1.2 KΩ, 5 %, 1/16 W, 0402 | Kamaya | RMC1/16S-122JTH |
| L8 | IND, 1.6nH, +/-0.1 nH, 0402 | Murata | LQG15HS1N6B02D |
| L4, L5 | IND, 560nH, 5 %, 0603 | Coilcraft | 0603LS-561XJLB |
| T1, T2 | TRANSFORMER, 1:1 | Mini Circuits | TC1-33-75-7+ |
| J3 | CONN, HDR | Samtec | TSW-103-07-G-S |
| J1, J2 | CONN, F FEM, 75OHM | Millimeter Wave | MW-846-C-DD-75 |

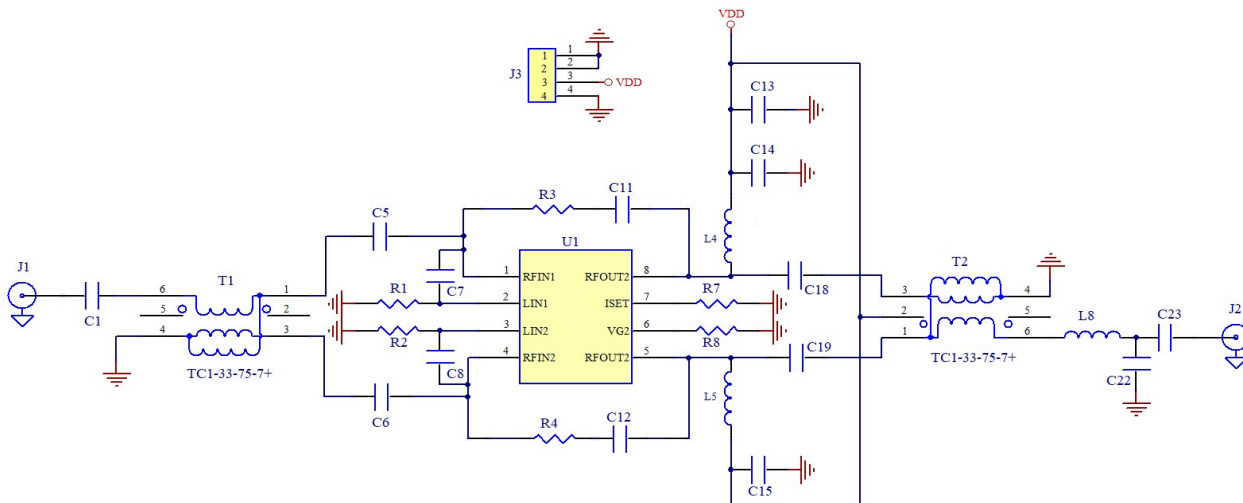
Simplified Application Schematic for Upstream (5 – 700 MHz)

Bill of Material for Simplified Application: Upstream (5 – 700 MHz)

| Reference Designator | Description | Manufacturer | Part Number |
|---------------------------------|-------------------------------------|-----------------|--------------------|
| U1 | 1218 MHz, 17 dB Push-Pull Amp | Qorvo | QPL8831SB |
| PCB | EVB PCB, QPL8831 | Qorvo | QPL883x-4001 |
| C22 | CAP, 0.2 pF, +/-0.05 pF, 50 V, 0402 | Johanson | 500R07S0R2AV4T |
| C7, C8, C11, C12, C13, C14, C15 | CAP, 0.01 uF, 10 %, 50 V, 0402 | Murata | GCM155R71H103KA55D |
| C1, C5, C6, C18, C19, C23 | CAP, 2.2uF, 10%, 16V, X5R, 0402 | Murata | GRM155R61C225KE11D |
| R7 | RES, 1.5 KΩ, 5 %, 1/16 W, 0402 | Kamaya | RMC1/16S-152JTH |
| R8 | RES, 3.9 KΩ, 5 %, 1/16 W, 0402 | Kamaya | RMC1/16S-392JTH |
| R3, R4 | RES, 470 Ω, 5 %, 1/16 W, 0402 | Kamaya | RMC1/16S-471JTH |
| R1, R2 | RES, 1.2 KΩ, 5 %, 1/16 W, 0402 | Kamaya | RMC1/16S-122JTH |
| L8 | IND, 1.6nH, +/-0.1 nH, 0402 | Murata | LQG15HS1N6B02D |
| L4, L5 | IND, 10uH, 5 %, 0603 | Coilcraft | 0603HP-10NXJLW |
| T1, T2 | TRANSFORMER, 1:1 | Mini Circuits | TC1-33-75-7+ |
| J3 | CONN, HDR | Samtec | TSW-103-07-G-S |
| J1, J2 | CONN, F FEM, 75OHM | Millimeter Wave | MW-846-C-DD-75 |

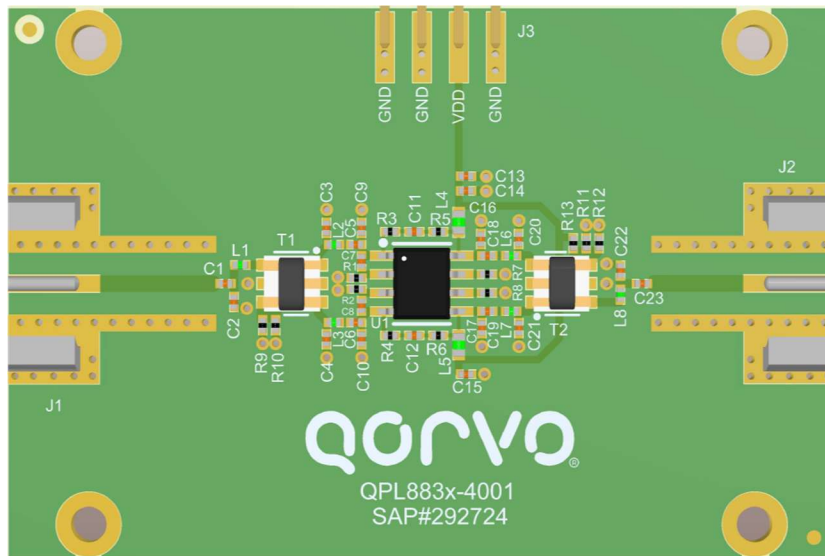
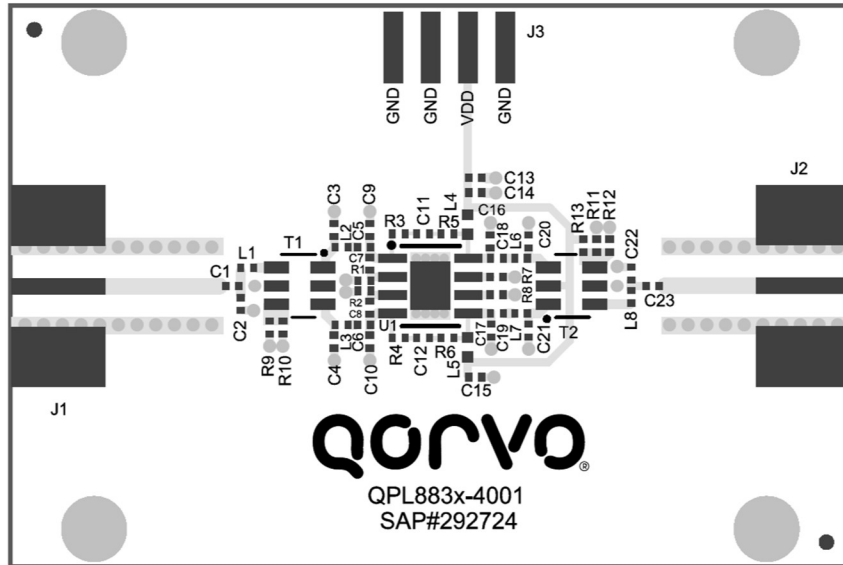
Evaluation Board Layout



EVB PCB Material and Stack-up

Board Material: 59.8mil FR4, $\epsilon_r=4.2$
 Plating: 1oz Copper
 Board Dimension: 2.250" x 1.500"

| Layer | Name | Material | Thickness | Constant | Board Layer Stack |
|-------|--------------|----------|-----------|----------|-------------------|
| | Top Overlay | | | | |
| | Top Solder | SM-001 | 0.40mil | 3.5 | |
| 1 | Top Layer | Copper | 0.70mil | | |
| | Dielectric 1 | FR4 | 58.00mil | 4.2 | |
| 2 | Bottom Layer | Copper | 0.70mil | | |

Total Thickness: 59.8mil

Performance Data at 5 V for Downstream (50 – 1218 MHz), 75Ω

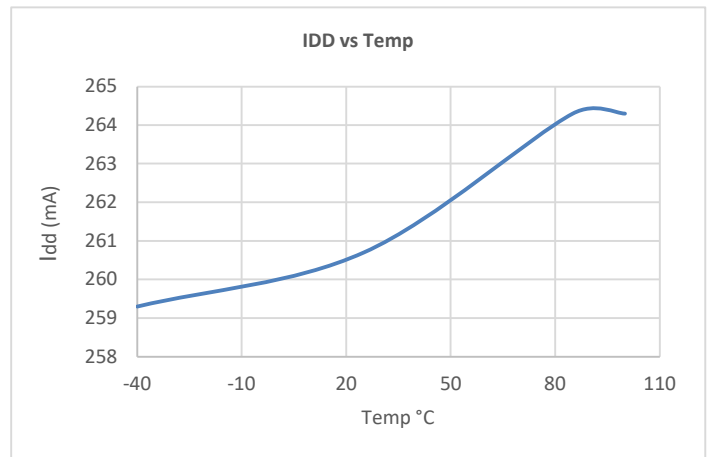
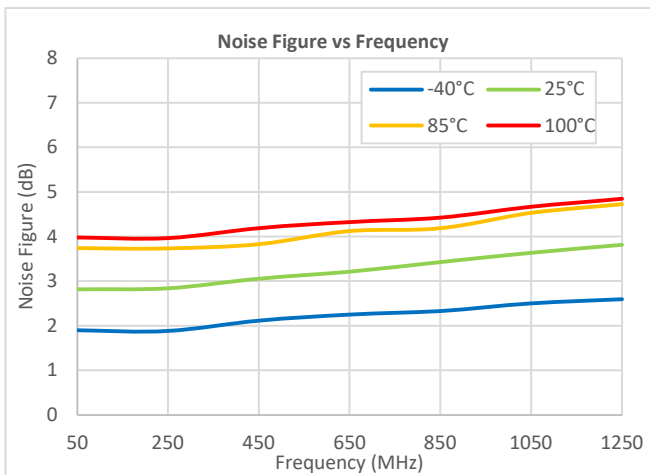
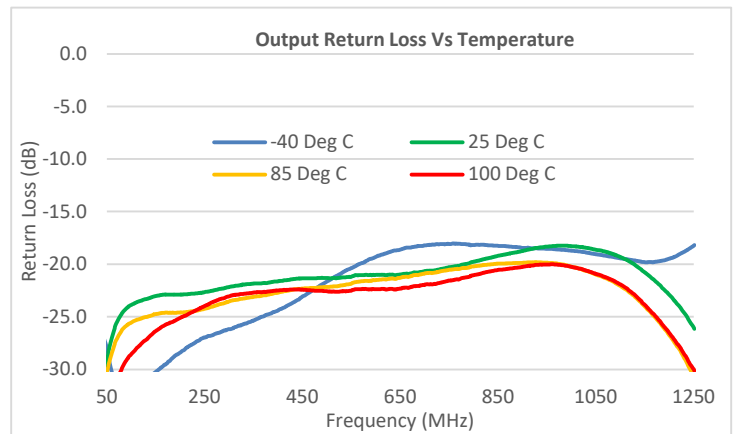
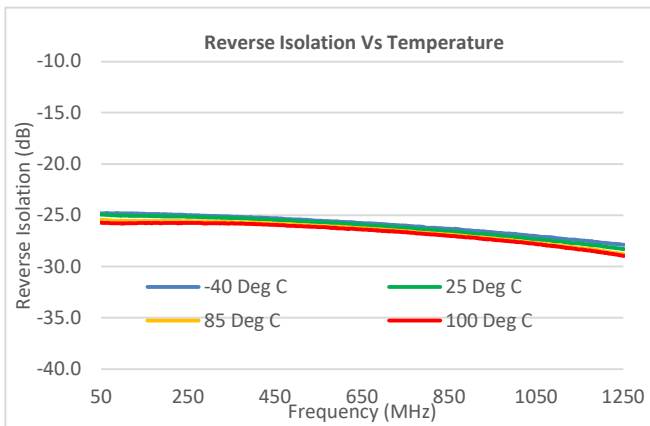
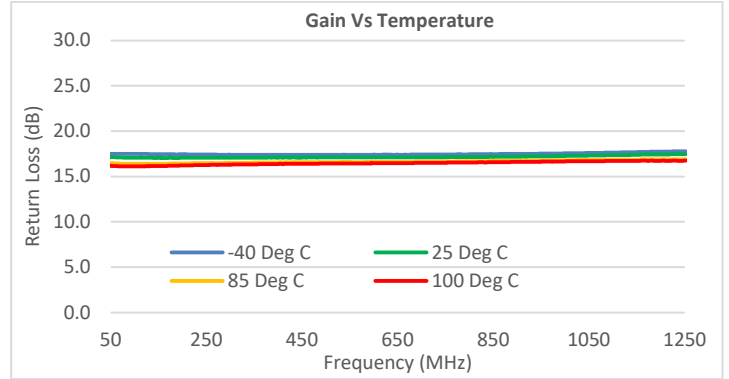
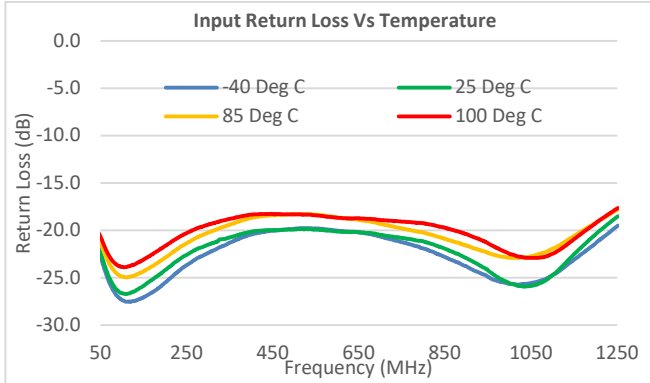

Performance Data at 5 V for Downstream (50 – 1218 MHz), 75Ω

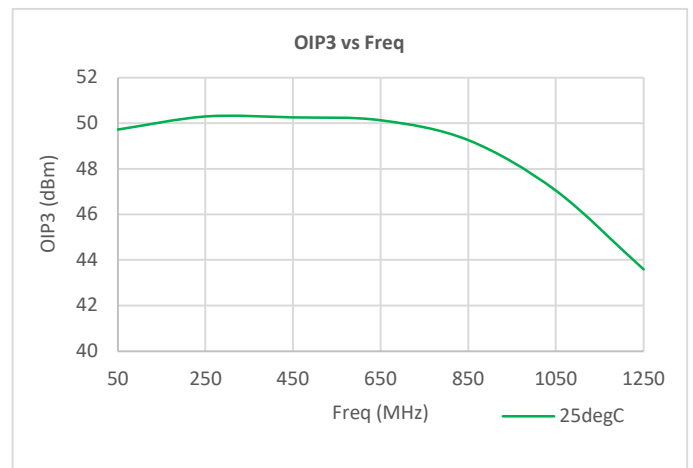
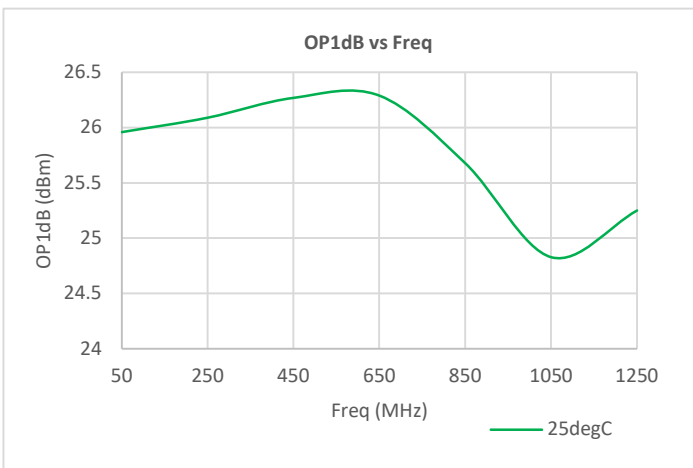
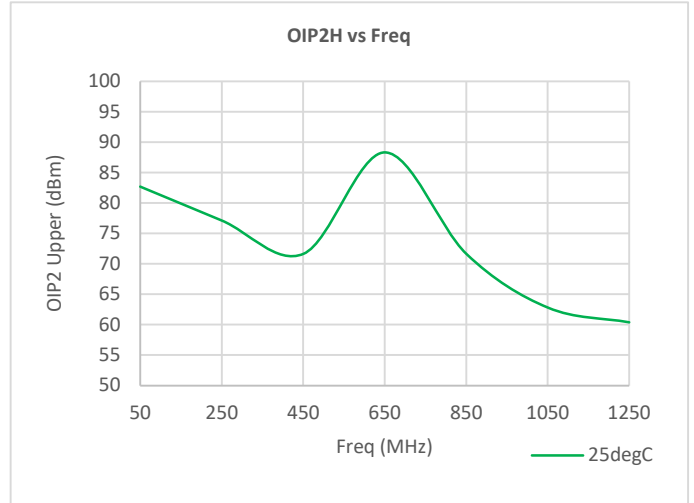
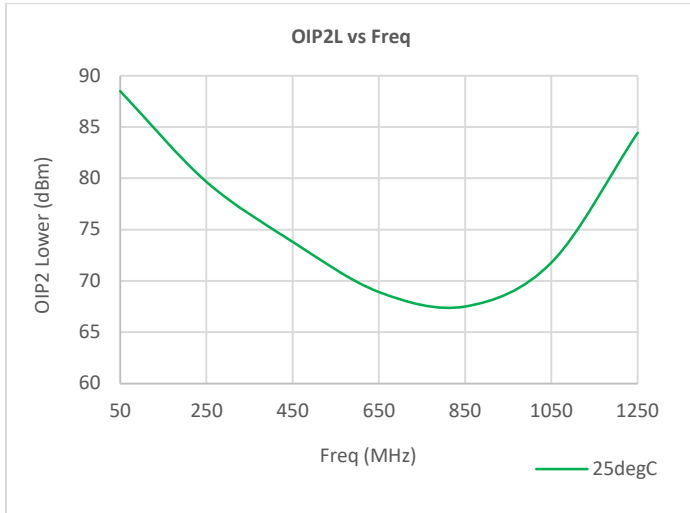

Notes:

1. OIP2: 13 dBm / tone output, $\Delta f = 50$ MHz, 50-1218 MHz.
2. OIP3: 13 dBm / tone output, $\Delta f = 6$ MHz, 50-1218 MHz.

Performance Data at 5V for Downstream (50 - 1218 MHz) with 0dB Tilt, 75Ω

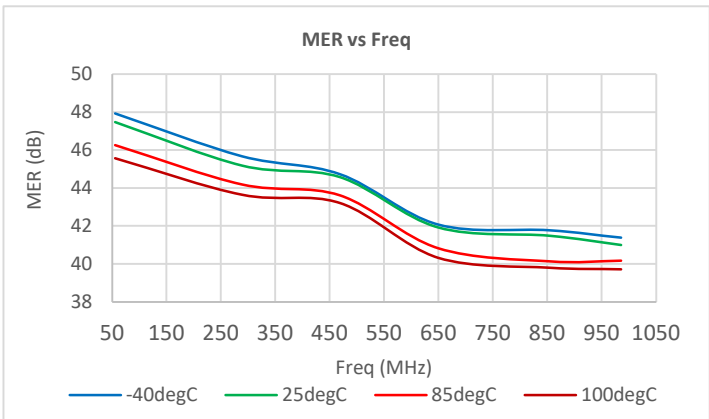
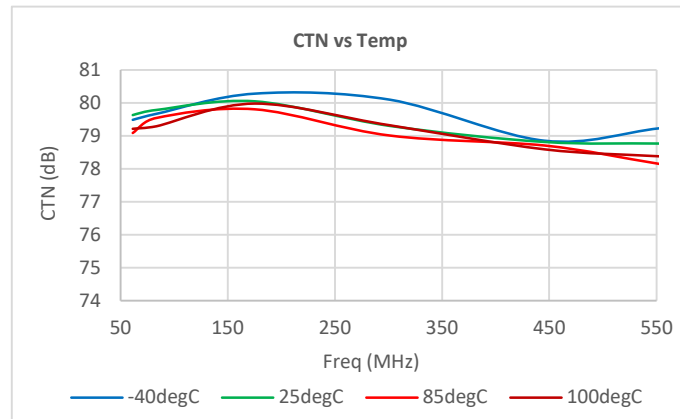
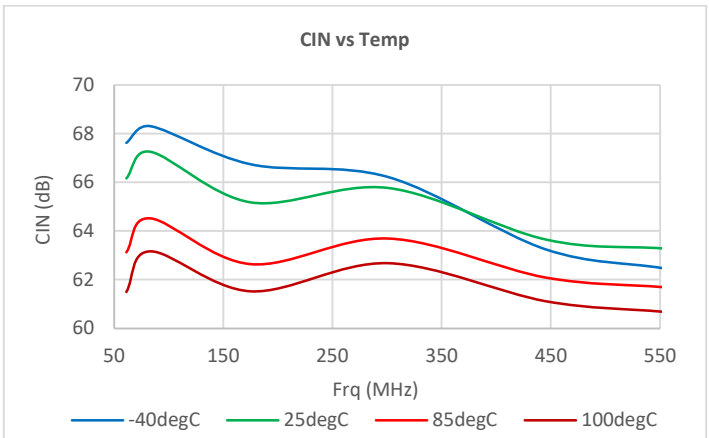
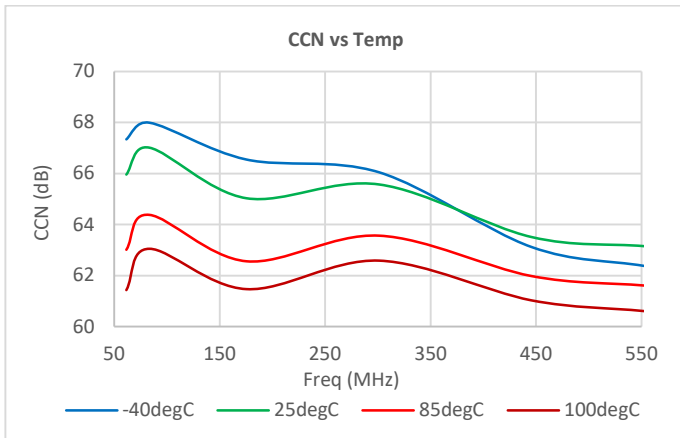
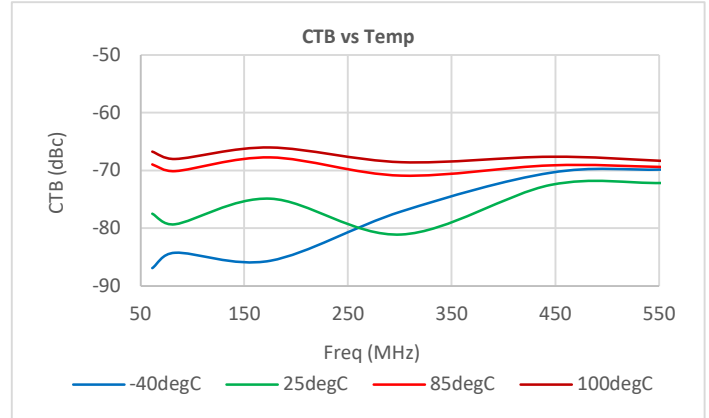
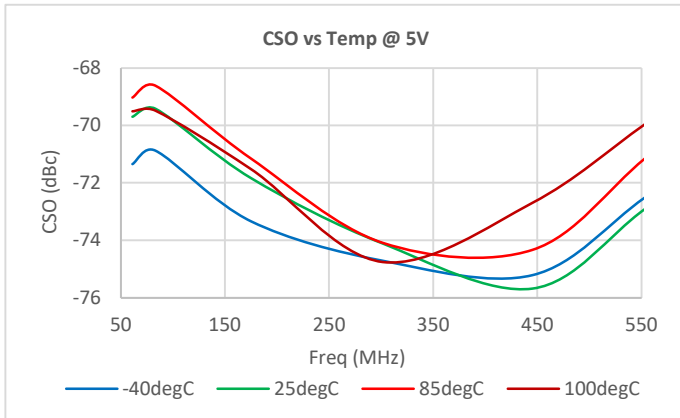

Notes:

1. For Composite Distortion Plots, 80Ch NTSC + 111QAM, 6dB offset, Pout = 43dBmV / Ch
2. For MER plot, TCP = 65dBmV, 160 Ch QAM

Performance Data at 5 V for Downstream (50 – 1218 MHz) with 10 dB Tilt, 75Ω

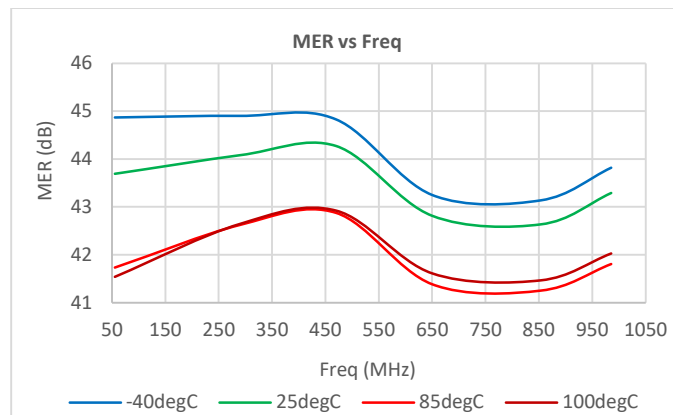
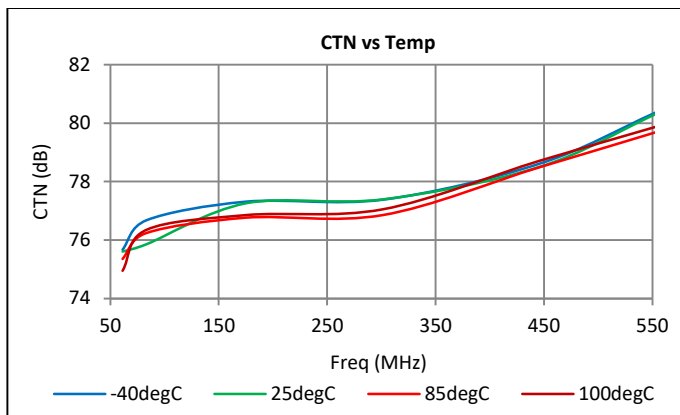
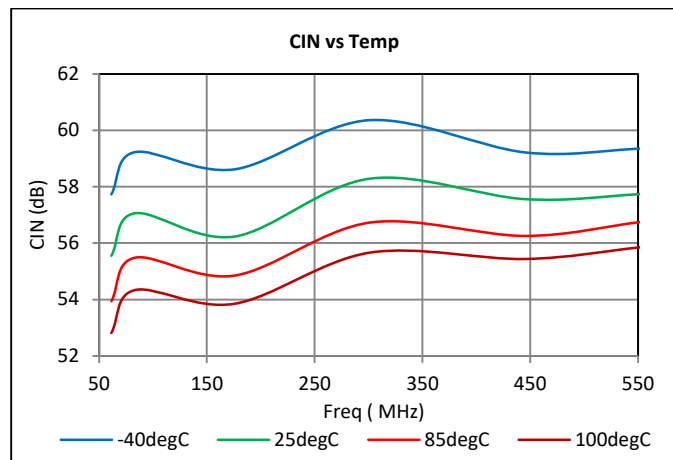
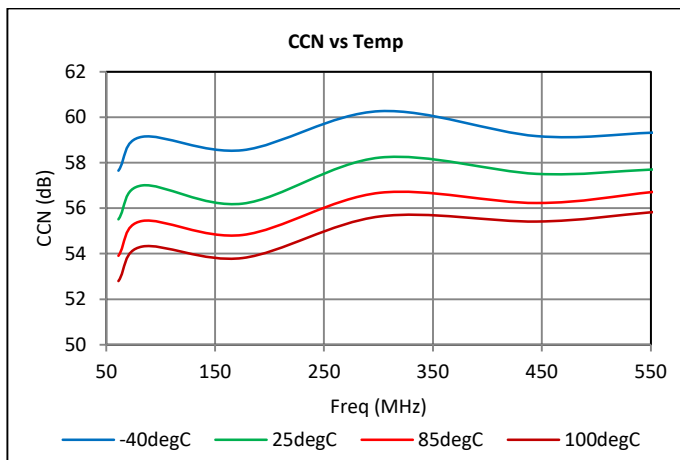
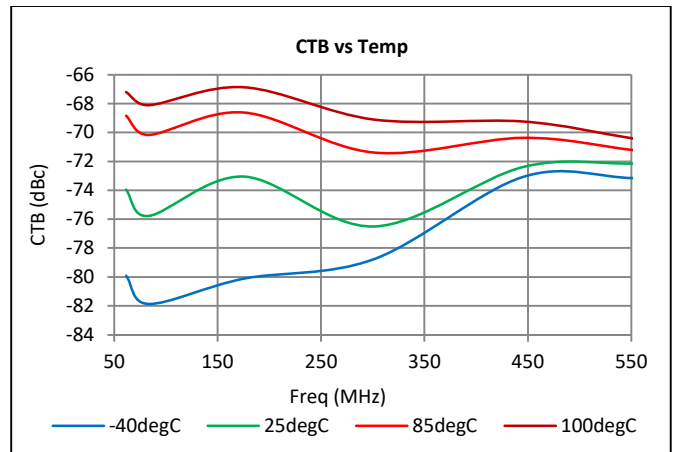
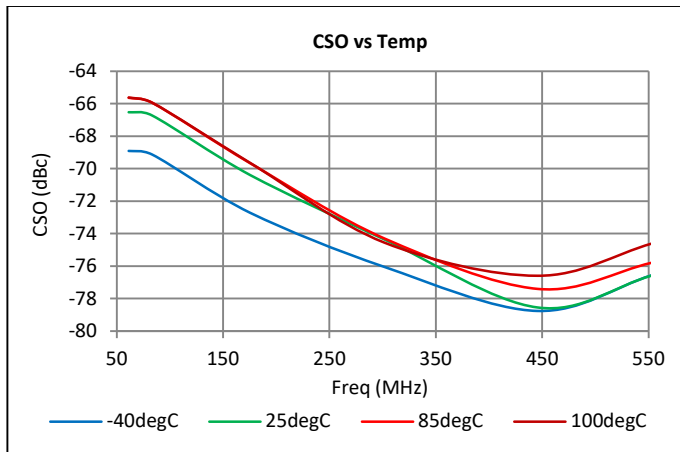

Notes:

1. For Composite Distortion Plots, 80Ch NTSC + 111 QAM, 6dB offset, Pout = 49 dBmV / Ch at 1218MHz virtual.
2. For MER plot, TCP = 65dBmV, 160 Ch QAM

Performance Data at 5 V for Upstream (5 – 700 MHz), 75Ω

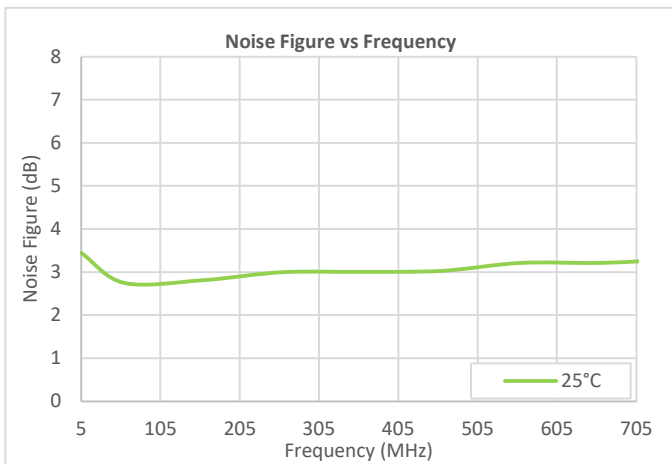
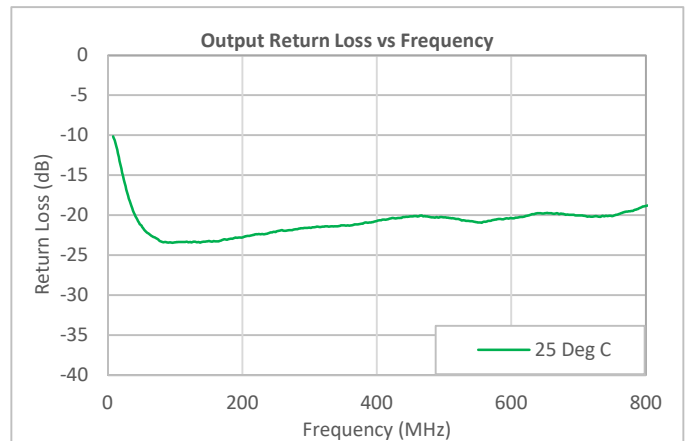
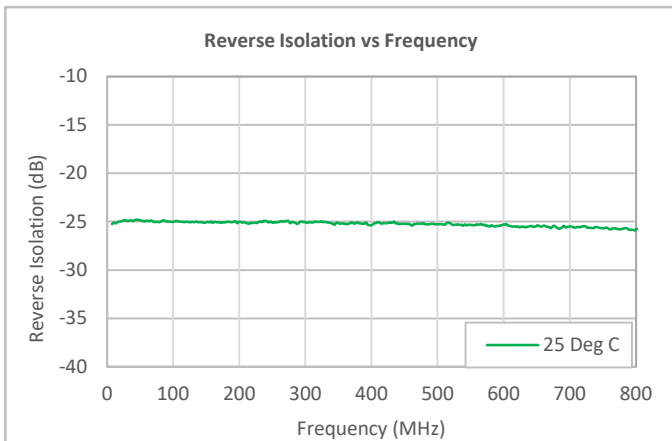
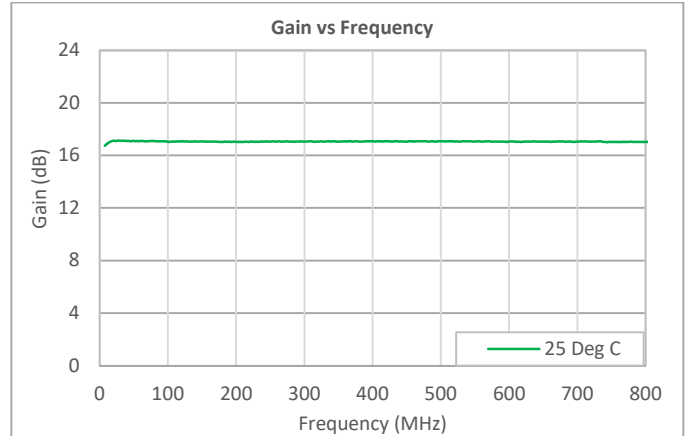
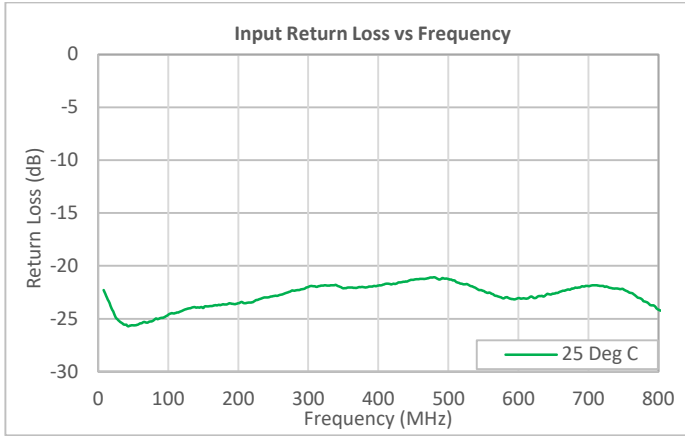

Performance Data at 5 V for Upstream (5 – 700 MHz), 75Ω

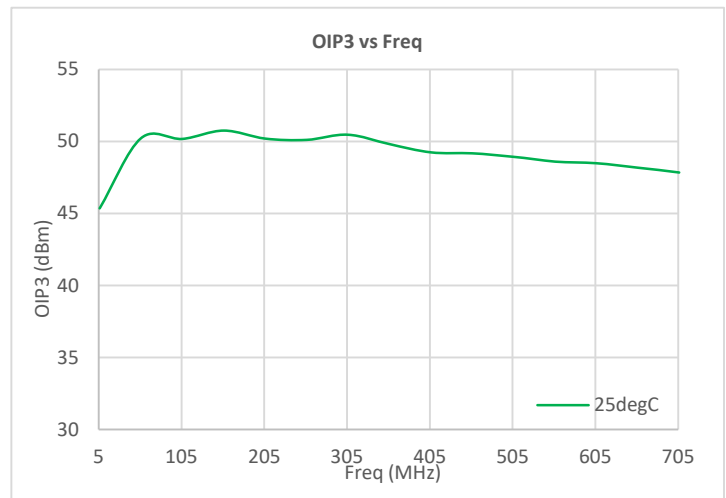
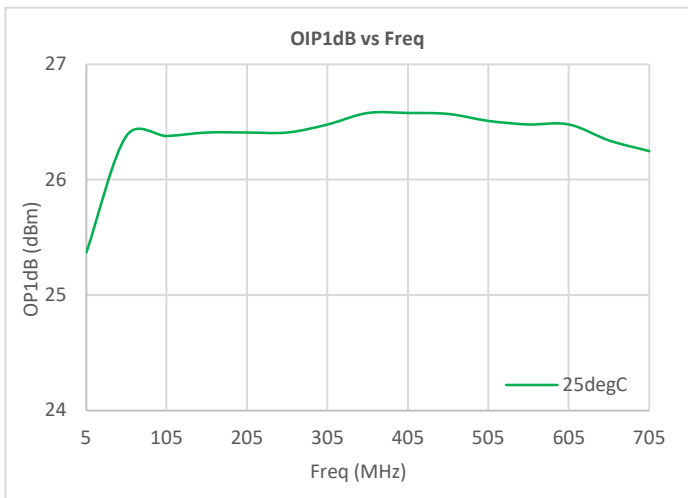
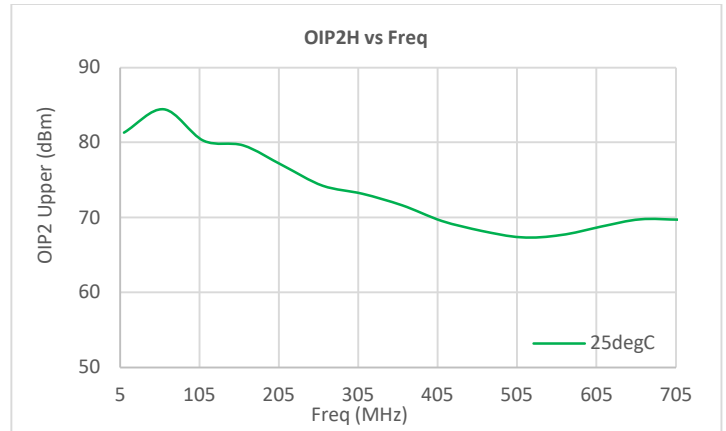
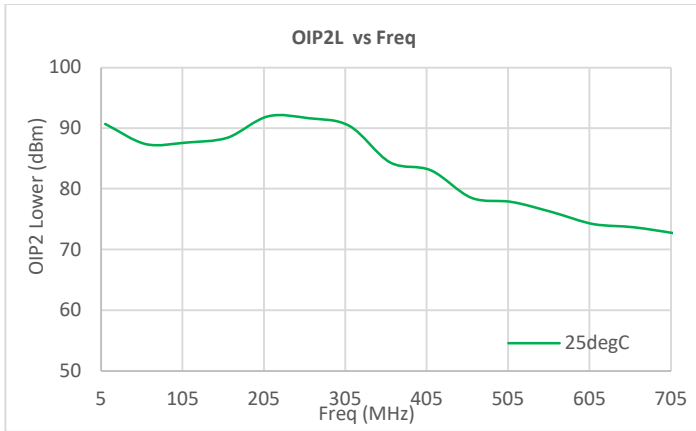

Notes:

1. OIP2: 13 dBm / tone output, $\Delta f = 50$ MHz, 5-700 MHz
2. OIP3: 13 dBm / tone output, $\Delta f = 6$ MHz, 5-700 MHz

Linearizer Current Settings

The linearizer circuitry is basically a pre-distortion circuit that can correct for 3rd order non-linearity. The amount of pre-distortion correction is set by ILIN. The linearizer circuit is coupled to the main amplifiers thru C7 and C8. Disconnecting C7 and C8 will disable the linearizer which causes the gain to increase slightly (~0.5dB) but will also degrade S11 and OIP3.

In the application circuit, R1 and R2 are used to set the linearizer current (ILIN). The ILIN can be calculated using the equation below.

$$ILIN = 2 \cdot (V_{DD} - 1.6V) / (R1 + 1125)$$

The value of ILIN has been optimized for the QPL8831 at 280mA. In applications where reduced IDD is needed, ILIN should also be reduced to achieve best linearity.

The graph on the right hand side shows the change in ILIN vs. R1, R2.

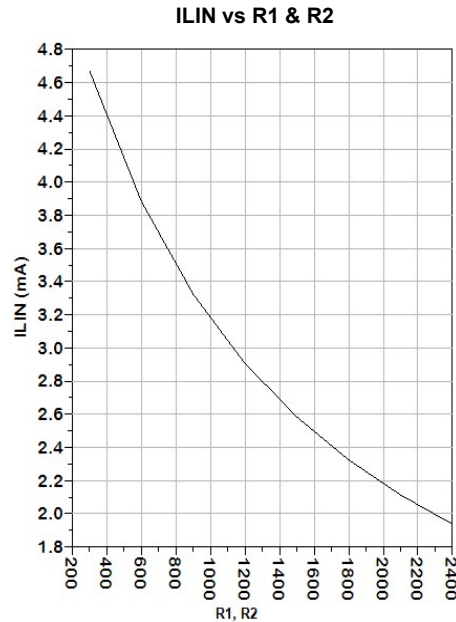

ISET Resistor Value

The resistor R7 is used to set the device current. In QPL8831 application circuit, the value of R7 is set to get an IDD of 280mA which is optimal for linearity at 5V. In applications where reduced linearity is acceptable, IDD can be reduced lowering the value of R7 (see graph below).

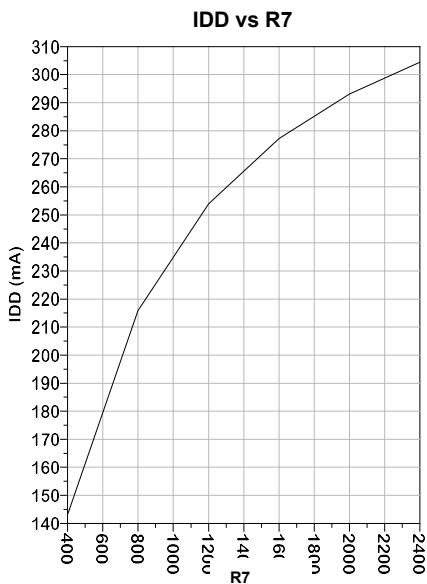

VG2 Resistor Value Settings

VG2 (pin 6) is connected to the gate of the output device. Resistor R8 is used to fine tune VG2 for best linearity.

Recommended range for R8 is 3k to 7k.

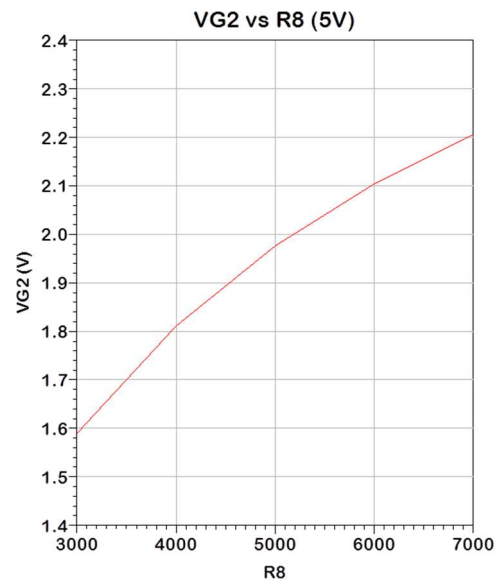

Package Marking

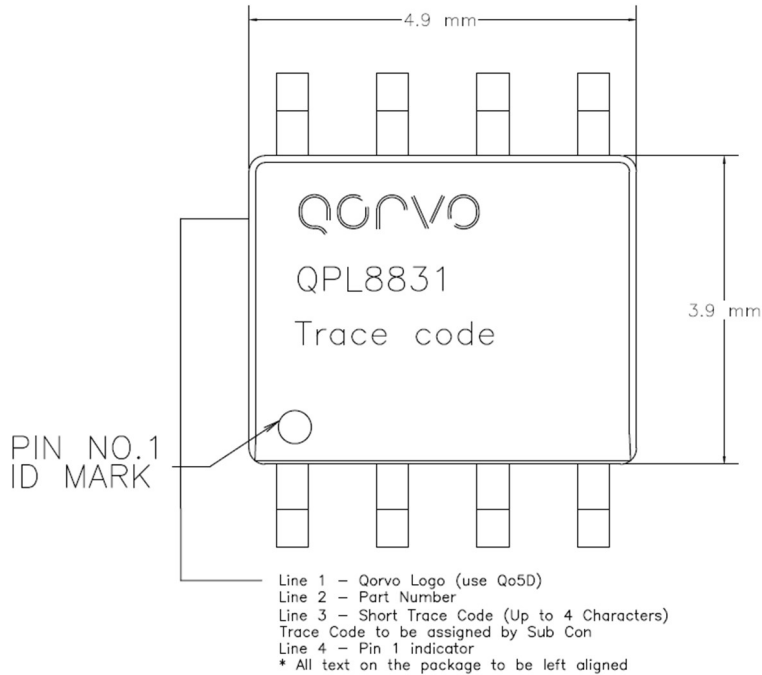

Pin Configuration and Description

| Pin | Name | Description |
|-----|--------|--|
| 1 | RFIN1 | RF input for plus side of amplifier |
| 2 | LIN1 | Linearizer Current Set for plus side of amplifier |
| 3 | LIN2 | Linearizer Current Set for minus side of amplifier |
| 4 | RFIN2 | RF input for minus side of amplifier |
| 5 | RFOUT2 | RF output for minus side of amplifier |
| 6 | VG2 | VG2 Adjust |
| 7 | ISET | IDD Set |
| 8 | RFOUT1 | RF output for plus side of amplifier |
| 9 | GND | Exposed bottom of part, device ground |

Handling Precautions

| Parameter | Rating | Standard |
|----------------------------------|----------|---------------------|
| ESD – Human Body Model (HBM) | Class 1B | ESDA/JEDEC JS-001 |
| ESD – Charged Device Model (CDM) | Class C3 | ESDA/JEDEC JS-002 |
| MSL – Moisture Sensitivity Level | Level 3 | IPC/JEDEC J-STD-020 |



Caution!
ESD-Sensitive Device

Solderability

Compatible with both lead-free (260 °C max. reflow temp.) and tin/lead (245 °C max. reflow temp.) soldering processes.

Solder profiles available upon request.

Contact plating: NiPdAu

RoHS Compliance

This part is compliant with 2011/65/EU RoHS directive (Restrictions on the Use of Certain Hazardous Substances in Electrical and Electronic Equipment) as amended by Directive 2015/863/EU.

This product also has the following attributes:

- Lead Free
- Halogen Free (Chlorine, Bromine)
- Antimony Free
- TBBP-A (C₁₅H₁₂Br₄O₂) Free
- PFOS Free
- SVHC Free



Contact Information

For the latest specifications, additional product information, worldwide sales and distribution locations:

Tel: **1-844-890-8163**

Web: www.qorvo.com

Email: customer.support@qorvo.com

Important Notice

The information contained herein is believed to be reliable; however, Qorvo makes no warranties regarding the information contained herein and assumes no responsibility or liability whatsoever for the use of the information contained herein. All information contained herein is subject to change without notice. Customers should obtain and verify the latest relevant information before placing orders for Qorvo products. The information contained herein or any use of such information does not grant, explicitly or implicitly, to any party any patent rights, licenses, or any other intellectual property rights, whether with regard to such information itself or anything described by such information. **THIS INFORMATION DOES NOT CONSTITUTE A WARRANTY WITH RESPECT TO THE PRODUCTS DESCRIBED HEREIN, AND QORVO HEREBY DISCLAIMS ANY AND ALL WARRANTIES WITH RESPECT TO SUCH PRODUCTS WHETHER EXPRESS OR IMPLIED BY LAW, COURSE OF DEALING, COURSE OF PERFORMANCE, USAGE OF TRADE OR OTHERWISE, INCLUDING THE IMPLIED WARRANTIES OF MERCHANTABILITY AND FITNESS FOR A PARTICULAR PURPOSE.**

Without limiting the generality of the foregoing, Qorvo products are not warranted or authorized for use as critical components in medical, life-saving, or life-sustaining applications, or other applications where a failure would reasonably be expected to cause severe personal injury or death.

Copyright 2019 © Qorvo, Inc. | Qorvo is a registered trademark of Qorvo, Inc.