

Applications

- Battery Management
- High Speed Power Switching
- Hard Switched and High Frequency Circuits

Benefits

- Improved Gate, Avalanche and Dynamic dv/dt Ruggedness
- Fully Characterized Capacitance and Avalanche SOA
- Enhanced body diode dV/dt and dI/dt Capability
- Lead-Free

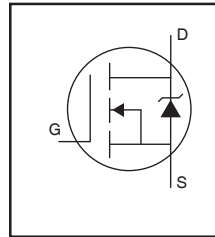

V_{DSS}	75V
$R_{DS(on)}$ typ. max.	5.0mΩ 6.4mΩ
I_D (Silicon Limited)	122A ①
I_D (Package Limited)	120A



G	D	S
Gate	Drain	Source

Ordering Information

Base part number	Package Type	Standard Pack		Complete Part Number
		Form	Quantity	
IRFB3407ZPbF	TO-220	Tube	50	IRFB3407ZPbF

Absolute Maximum Ratings

Symbol	Parameter	Max.	Units
$I_D @ T_C = 25^\circ C$	Continuous Drain Current, $V_{GS} @ 10V$ (Silicon Limited)	122①	A
$I_D @ T_C = 100^\circ C$	Continuous Drain Current, $V_{GS} @ 10V$ (Silicon Limited)	86	
$I_D @ T_C = 25^\circ C$	Continuous Drain Current, $V_{GS} @ 10V$ (Wire Bond Limited)	120	
I_{DM}	Pulsed Drain Current ②	488	
$P_D @ T_C = 25^\circ C$	Maximum Power Dissipation	230	W
	Linear Derating Factor	1.5	W/°C
V_{GS}	Gate-to-Source Voltage	± 20	V
dv/dt	Peak Diode Recovery ④	6.7	V/ns
T_J T_{STG}	Operating Junction and Storage Temperature Range	-55 to + 175	°C
	Soldering Temperature, for 10 seconds (1.6mm from case)	300	
	Mounting torque, 6-32 or M3 screw	10lbf·in (1.1N·m)	

Avalanche Characteristics

E_{AS} (Thermally limited)	Single Pulse Avalanche Energy ③	140	mJ
I_{AR}	Avalanche Current ②	See Fig. 14, 15, 21a, 21b	A
E_{AR}	Repetitive Avalanche Energy ②		mJ

Thermal Resistance

Symbol	Parameter	Typ.	Max.	Units
$R_{\theta JC}$	Junction-to-Case ⑤	—	0.65	°C/W
$R_{\theta CS}$	Case-to-Sink, Flat Greased Surface, TO-220	0.50	—	
$R_{\theta JA}$	Junction-to-Ambient, TO-220	—	62	

Static @ $T_J = 25^\circ\text{C}$ (unless otherwise specified)

Symbol	Parameter	Min.	Typ.	Max.	Units	Conditions
$V_{(BR)DSS}$	Drain-to-Source Breakdown Voltage	75	—	—	V	$V_{GS} = 0V, I_D = 250\mu A$
$\Delta V_{(BR)DSS}/\Delta T_J$	Breakdown Voltage Temp. Coefficient	—	0.094	—	V/ $^\circ\text{C}$	Reference to $25^\circ\text{C}, I_D = 5mA$ ②
$R_{DS(on)}$	Static Drain-to-Source On-Resistance	—	5.0	6.4	m Ω	$V_{GS} = 10V, I_D = 75A$ ③
$V_{GS(th)}$	Gate Threshold Voltage	2.0	—	4.0	V	$V_{DS} = V_{GS}, I_D = 150\mu A$
$R_{G(int)}$	Internal Gate Resistance	—	0.70	—	Ω	
I_{DSS}	Drain-to-Source Leakage Current	—	—	20	μA	$V_{DS} = 75V, V_{GS} = 0V$
		—	—	250		$V_{DS} = 75V, V_{GS} = 0V, T_J = 125^\circ\text{C}$
I_{GSS}	Gate-to-Source Forward Leakage	—	—	100	nA	$V_{GS} = 20V$
	Gate-to-Source Reverse Leakage	—	—	-100		$V_{GS} = -20V$

Dynamic @ $T_J = 25^\circ\text{C}$ (unless otherwise specified)

Symbol	Parameter	Min.	Typ.	Max.	Units	Conditions
gfs	Forward Transconductance	320	—	—	S	$V_{DS} = 50V, I_D = 75A$
Q_g	Total Gate Charge	—	79	110	nC	$I_D = 75A$
Q_{gs}	Gate-to-Source Charge	—	19	—		$V_{DS} = 38V$
Q_{gd}	Gate-to-Drain ("Miller") Charge	—	24	—		$V_{GS} = 10V$ ⑤
Q_{sync}	Total Gate Charge Sync. ($Q_g - Q_{gd}$)	—	55	—		$I_D = 75A, V_{DS} = 0V, V_{GS} = 10V$
$t_{d(on)}$	Turn-On Delay Time	—	15	—	ns	$V_{DD} = 49V$
t_r	Rise Time	—	64	—		$I_D = 75A$
$t_{d(off)}$	Turn-Off Delay Time	—	38	—		$R_G = 2.6\Omega$
t_f	Fall Time	—	65	—		$V_{GS} = 10V$ ⑤
C_{iss}	Input Capacitance	—	4750	—	pF	$V_{GS} = 0V$
C_{oss}	Output Capacitance	—	420	—		$V_{DS} = 50V$
C_{rss}	Reverse Transfer Capacitance	—	190	—		$f = 1.0MHz$
$C_{oss \text{ eff. (ER)}}$	Effective Output Capacitance (Energy Related)	—	440	—		$V_{GS} = 0V, V_{DS} = 0V \text{ to } 60V$ ⑦
$C_{oss \text{ eff. (TR)}}$	Effective Output Capacitance (Time Related)	—	410	—		$V_{GS} = 0V, V_{DS} = 0V \text{ to } 60V$ ⑥

Diode Characteristics

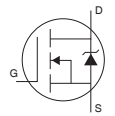
Symbol	Parameter	Min.	Typ.	Max.	Units	Conditions
I_S	Continuous Source Current (Body Diode)	—	—	120 ①	A	MOSFET symbol showing the integral reverse p-n junction diode. 
I_{SM}	Pulsed Source Current (Body Diode) ② ③	—	—	488		
V_{SD}	Diode Forward Voltage	—	—	1.3	V	$T_J = 25^\circ\text{C}, I_S = 75A, V_{GS} = 0V$ ⑤
t_{rr}	Reverse Recovery Time	—	33	50	ns	$T_J = 25^\circ\text{C}$ $V_R = 64V,$
		—	39	59		$T_J = 125^\circ\text{C}$ $I_F = 75A$
Q_{rr}	Reverse Recovery Charge	—	42	63	nC	$T_J = 25^\circ\text{C}$ $di/dt = 100A/\mu s$ ⑤
		—	56	84		$T_J = 125^\circ\text{C}$
I_{RRM}	Reverse Recovery Current	—	2.2	—	A	$T_J = 25^\circ\text{C}$
t_{on}	Forward Turn-On Time	Intrinsic turn-on time is negligible (turn-on is dominated by LS+LD)				

Notes:

- ① Calculated continuous current based on maximum allowable junction temperature. Bond wire current limit is 120A. Note that current limitations arising from heating of the device leads may occur with some lead mounting arrangements.
- ② Repetitive rating; pulse width limited by max. junction temperature.
- ③ Limited by T_{Jmax} , starting $T_J = 25^\circ\text{C}, L = 0.050mH$
 $R_G = 25\Omega, I_{AS} = 75A, V_{GS} = 10V$. Part not recommended for use above this value.
- ④ $I_{SD} \leq 75A, di/dt \leq 1570A/\mu s, V_{DD} \leq V_{(BR)DSS}, T_J \leq 175^\circ\text{C}$.
- ⑤ Pulse width $\leq 400\mu s$; duty cycle $\leq 2\%$.
- ⑥ $C_{oss \text{ eff. (TR)}}$ is a fixed capacitance that gives the same charging time as C_{oss} while V_{DS} is rising from 0 to 80% V_{DSS} .
- ⑦ $C_{oss \text{ eff. (ER)}}$ is a fixed capacitance that gives the same energy as C_{oss} while V_{DS} is rising from 0 to 80% V_{DSS} .
- ⑧ R_θ is measured at T_J approximately 90°C .

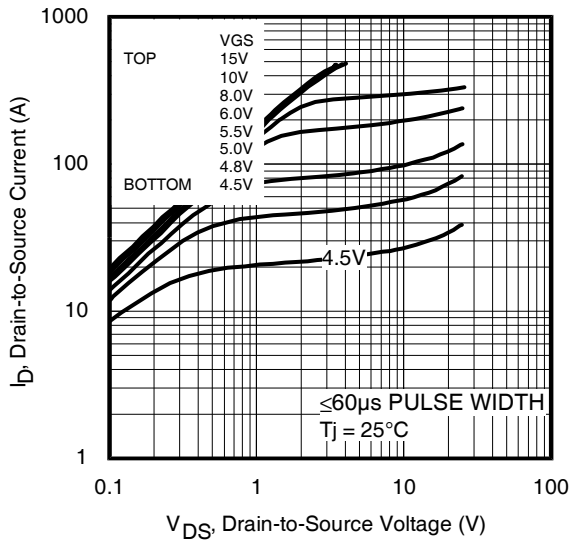
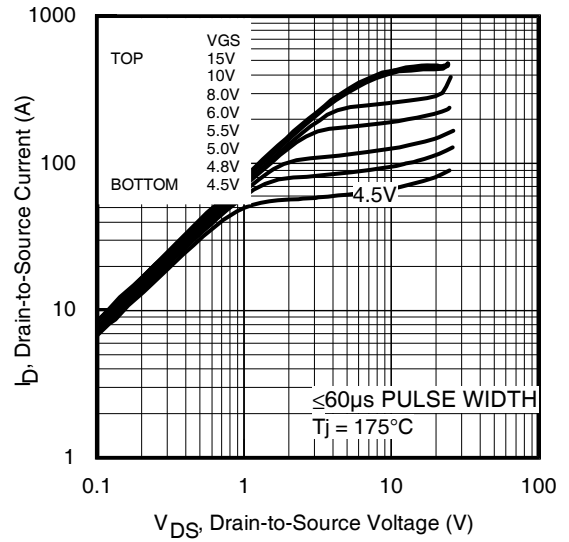
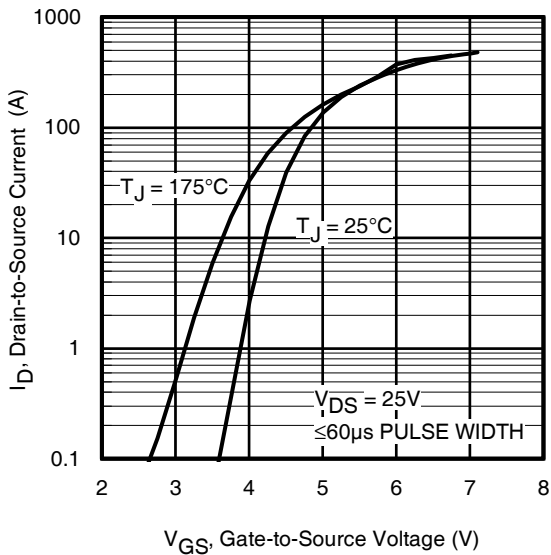
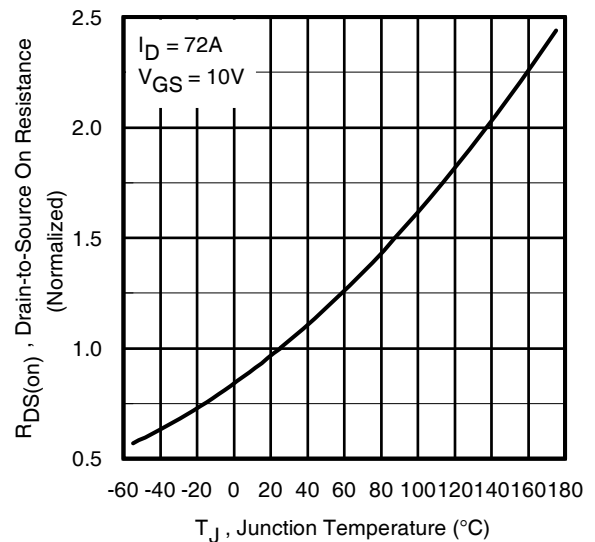
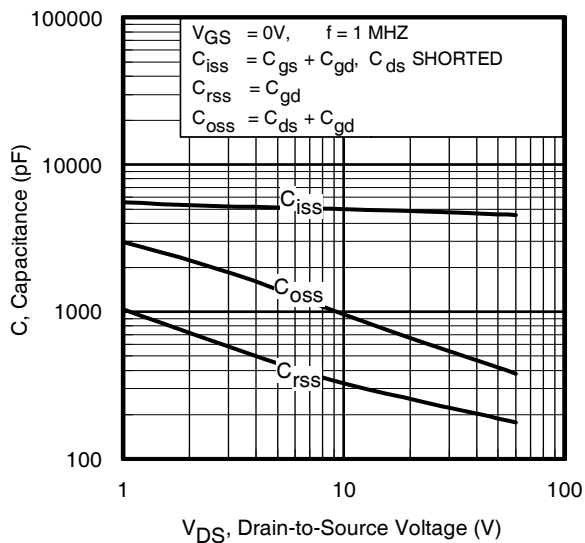
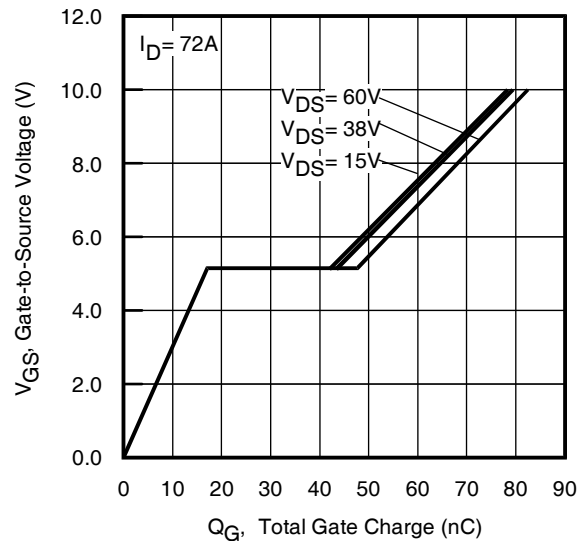
Fig 1. Typical Output Characteristics

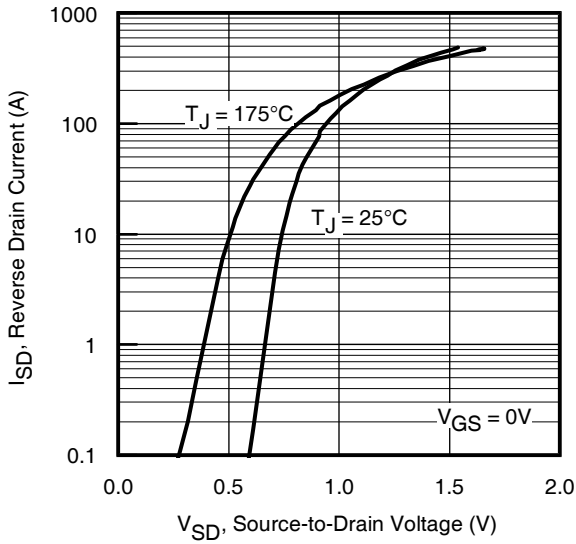
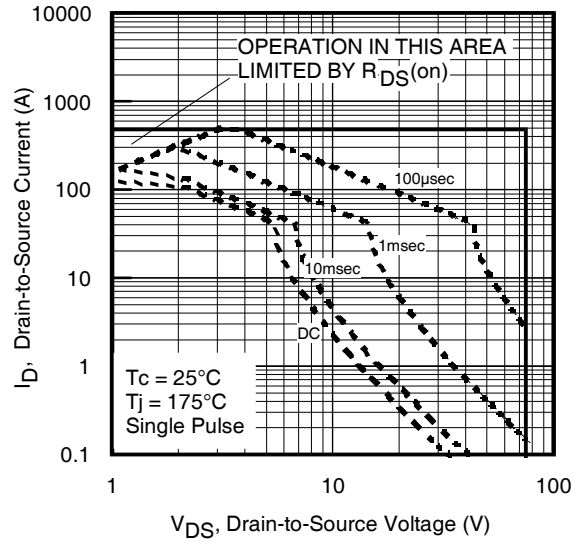
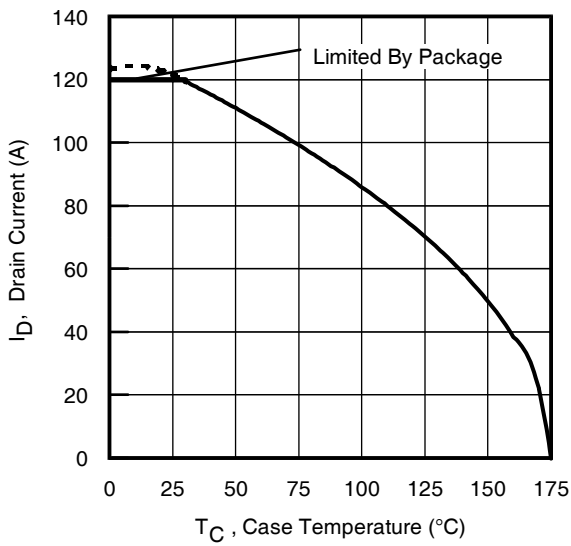
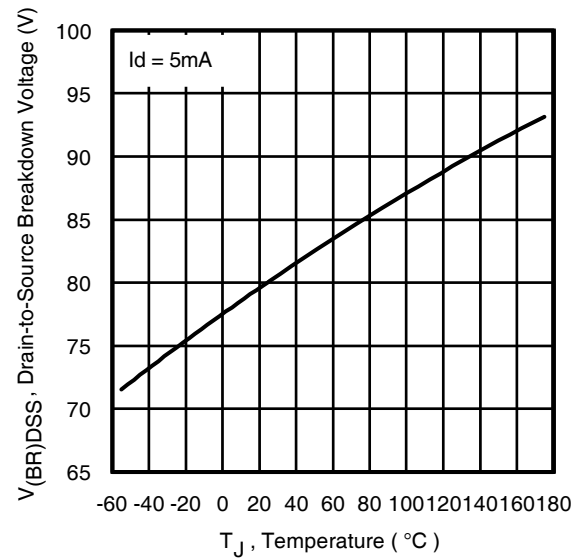
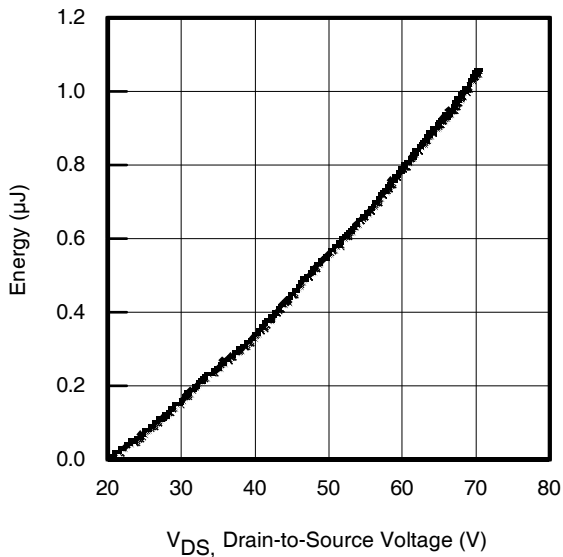
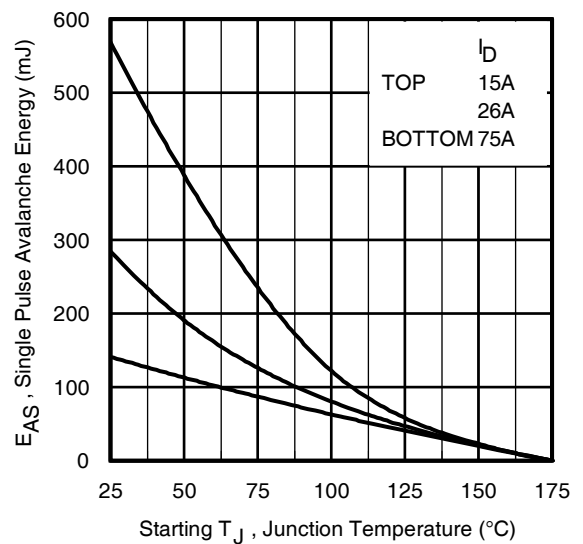
Fig 2. Typical Output Characteristics

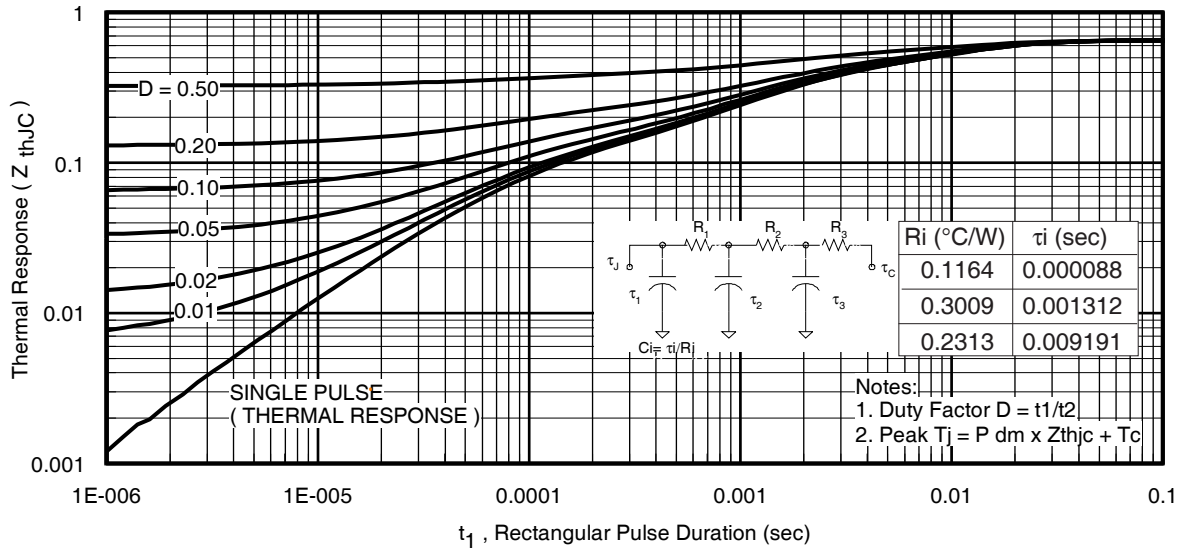
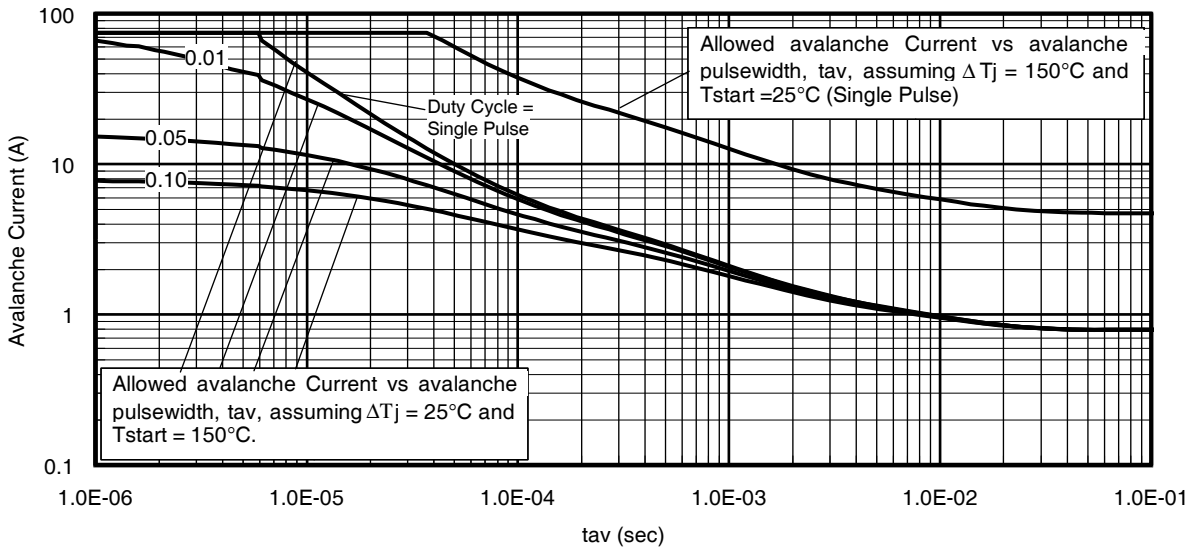
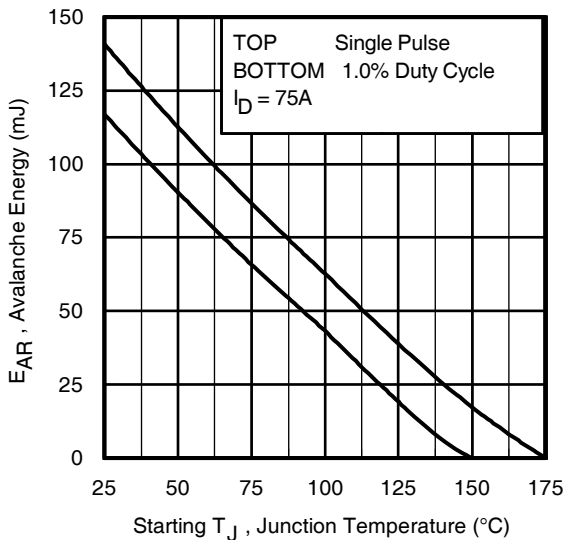
Fig 3. Typical Transfer Characteristics

Fig 4. Normalized On-Resistance vs. Temperature

Fig 5. Typical Capacitance vs. Drain-to-Source Voltage

Fig 6. Typical Gate Charge vs. Gate-to-Source Voltage

Fig 7. Typical Source-Drain Diode Forward Voltage

Fig 8. Maximum Safe Operating Area

Fig 9. Maximum Drain Current vs. Case Temperature

Fig 10. Drain-to-Source Breakdown Voltage

Fig 11. Typical C_{OSS} Stored Energy

Fig 12. Maximum Avalanche Energy vs. Drain Current

Fig 13. Maximum Effective Transient Thermal Impedance, Junction-to-Case

Fig 14. Typical Avalanche Current vs. Pulsewidth

**Notes on Repetitive Avalanche Curves, Figures 14, 15:
 (For further info, see AN-1005 at www.irf.com)**

1. Avalanche failures assumption:
Purely a thermal phenomenon and failure occurs at a temperature far in excess of T_{jmax} . This is validated for every part type.
2. Safe operation in Avalanche is allowed as long as T_{jmax} is not exceeded.
3. Equation below based on circuit and waveforms shown in Figures 21a, 21b.
4. $P_{D(ave)}$ = Average power dissipation per single avalanche pulse.
5. BV = Rated breakdown voltage (1.3 factor accounts for voltage increase during avalanche).
6. I_{av} = Allowable avalanche current.
7. ΔT = Allowable rise in junction temperature, not to exceed T_{jmax} (assumed as 25°C in Figure 14, 15).
 t_{av} = Average time in avalanche.
 D = Duty cycle in avalanche = $t_{av} \cdot f$
 $Z_{thJC}(D, t_{av})$ = Transient thermal resistance, see Figures 13)

$$P_{D(ave)} = 1/2 (1.3 \cdot BV \cdot I_{av}) = \Delta T / Z_{thJC}$$

$$I_{av} = 2\Delta T / [1.3 \cdot BV \cdot Z_{th}]$$

$$E_{AS(AR)} = P_{D(ave)} \cdot t_{av}$$

Fig 15. Maximum Avalanche Energy vs. Temperature

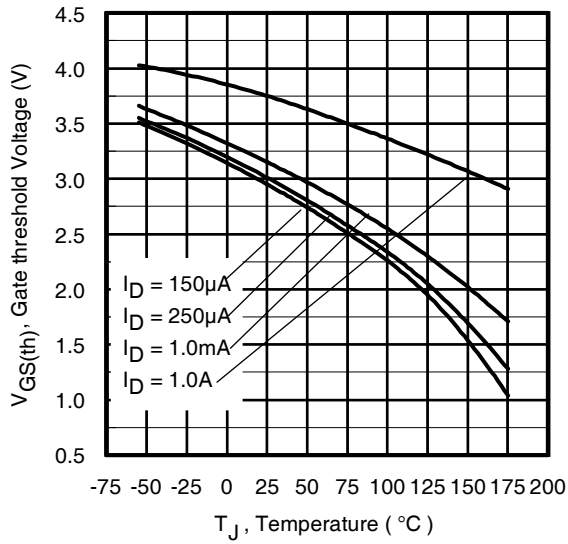
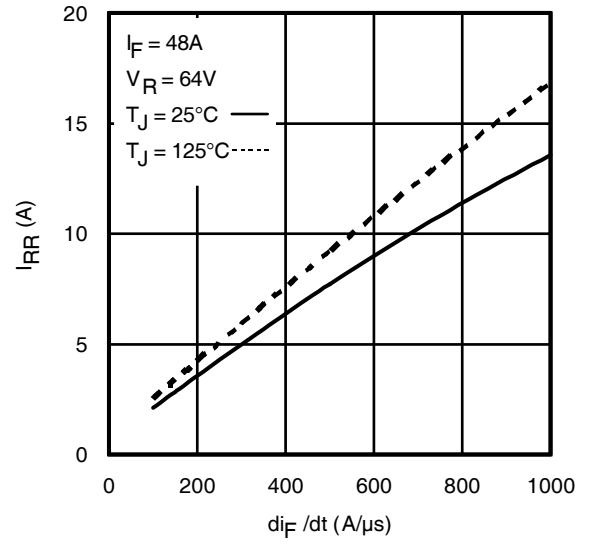
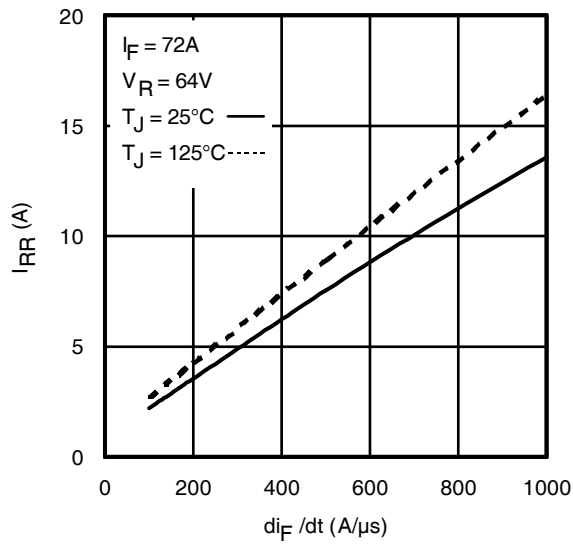
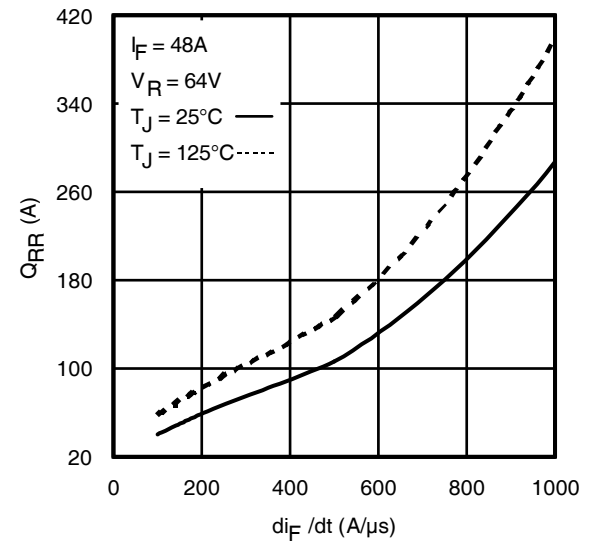
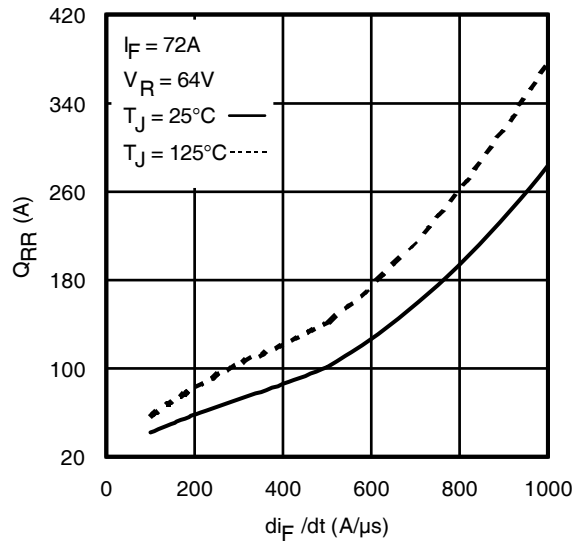
Fig 16. Threshold Voltage vs. Temperature

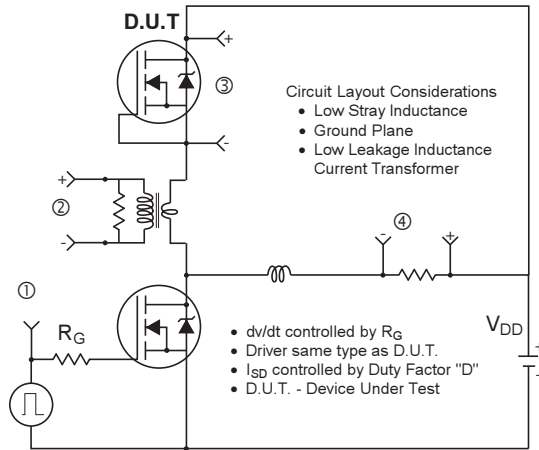
Fig. 17 - Typical Recovery Current vs. di_f/dt

Fig. 18 - Typical Recovery Current vs. di_f/dt

Fig. 19 - Typical Stored Charge vs. di_f/dt

Fig. 20 - Typical Stored Charge vs. di_f/dt



* $V_{GS} = 5V$ for Logic Level Devices

Fig 20. Peak Diode Recovery dv/dt Test Circuit for N-Channel HEXFET® Power MOSFETs

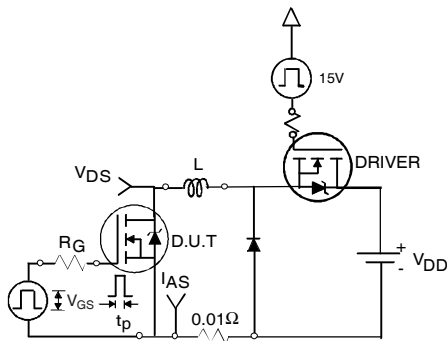

Fig 21a. Unclamped Inductive Test Circuit



Fig 21b. Unclamped Inductive Waveforms

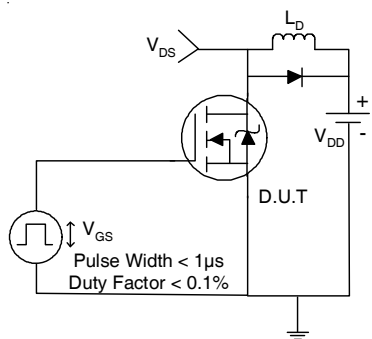

Fig 22a. Switching Time Test Circuit

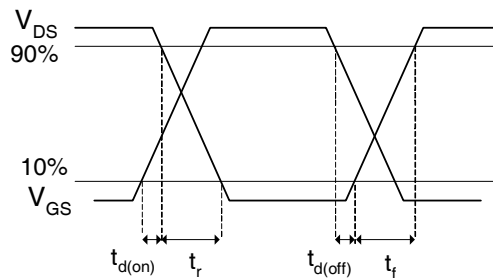

Fig 22b. Switching Time Waveforms

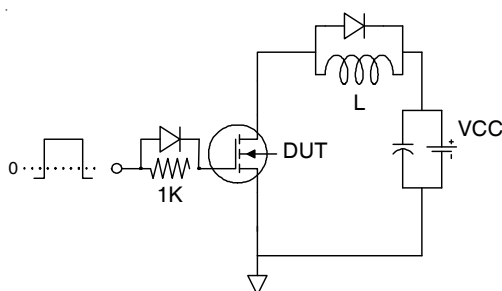

Fig 23a. Gate Charge Test Circuit

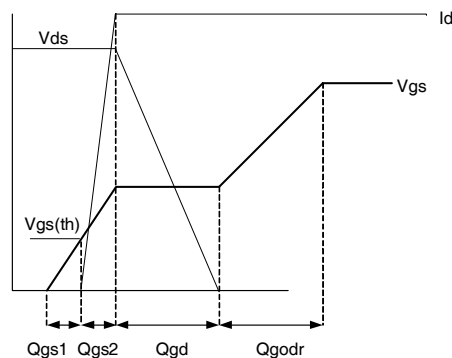
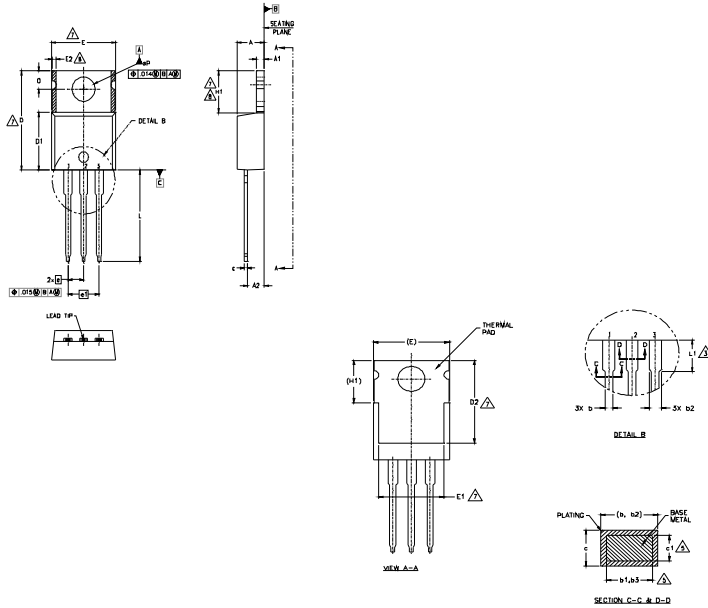

Fig 23b. Gate Charge Waveform

TO-220AB Package Outline

Dimensions are shown in millimeters (inches)



NOTES:

- 1.- DIMENSIONING AND TOLERANCING AS PER ASME Y14.5 M- 1994.
- 2.- DIMENSIONS ARE SHOWN IN INCHES [MILLIMETERS]
- 3.- LEAD DIMENSION AND FINISH UNCONTROLLED IN L1.
- 4.- DIMENSION D, D1 & E DO NOT INCLUDE MOLD FLASH. MOLD FLASH SHALL NOT EXCEED .005" (0.127) PER SIDE. THESE DIMENSIONS ARE MEASURED AT THE OUTERMOST EXTREMES OF THE PLASTIC BODY.
- 5.- DIMENSION b1, b3 & c1 APPLY TO BASE METAL ONLY.
- 6.- CONTROLLING DIMENSION : INCHES.
- 7.- THERMAL PAD CONTOUR OPTIONAL WITHIN DIMENSIONS E,H1,D2 & E1
- 8.- DIMENSION E2 X H1 DEFINE A ZONE WHERE STAMPING AND SINGULATION IRREGULARITIES ARE ALLOWED.
- 9.- OUTLINE CONFORMS TO JEDEC TO-220, EXCEPT A2 (max.) AND D2 (min.) WHERE DIMENSIONS ARE DERIVED FROM THE ACTUAL PACKAGE OUTLINE.

SYMBOL	DIMENSIONS				NOTES
	MILLIMETERS		INCHES		
	MIN.	MAX.	MIN.	MAX.	
A	3.56	4.83	.140	.190	
A1	0.51	1.40	.020	.055	
A2	2.03	2.92	.080	.115	
b	0.38	1.01	.015	.040	
b1	0.38	0.97	.015	.038	5
b2	1.14	1.78	.045	.070	
b3	1.14	1.73	.045	.068	5
c	0.36	0.61	.014	.024	
c1	0.36	0.56	.014	.022	5
D	14.22	16.51	.560	.650	4
D1	8.38	9.02	.330	.355	
D2	11.68	12.88	.460	.507	7
E	9.65	10.67	.380	.420	4,7
E1	6.86	8.89	.270	.350	7
E2	-	0.76	-	.030	8
e	2.54 BSC		.100 BSC		
e1	5.08 BSC		.200 BSC		
H1	5.84	6.86	.230	.270	7,8
L	12.70	14.73	.500	.580	
L1	3.56	4.06	.140	.160	3
øP	3.54	4.08	.139	.161	
Q	2.54	3.42	.100	.135	

LEAD ASSIGNMENTS

- HEXFET
 1.- GATE
 2.- DRAIN
 3.- SOURCE

IGBTs, CoPACK

- 1.- GATE
 2.- COLLECTOR
 3.- EMITTER

DIODES

- 1.- ANODE
 2.- CATHODE
 3.- ANODE

TO-220AB Part Marking Information

EXAMPLE: THIS IS AN IRFB4310GPBF

Note: "G" s suffix in part number indicates "Halogen - Free"

Note: "P" in assembly line position indicates "Lead - Free"

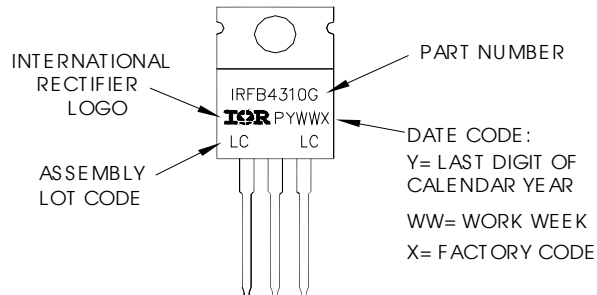

TO-220AB packages are not recommended for Surface Mount Application.

Note: For the most current drawing please refer to IR website at: <http://www.irf.com/package/>

Qualification information†

Qualification level	Industrial††	
	(per JEDEC JESD47F††† guidelines)	
Moisture Sensitivity Level	TO-220AB	N/A
		(per JEDEC J-STD-020D†††)
RoHS compliant	Yes	

† Qualification standards can be found at International Rectifier's web site: <http://www.irf.com/product-info/reliability/>

†† Higher qualification ratings may be available should the user have such requirements. Please contact your International Rectifier sales representative for further information: <http://www.irf.com/whoto-call/salesrep/>

††† Applicable version of JEDEC standard at the time of product release.

IMPORTANT NOTICE

The information given in this document shall in no event be regarded as a guarantee of conditions or characteristics ("Beschaffheitsgarantie").

With respect to any examples, hints or any typical values stated herein and/or any information regarding the application of the product, Infineon Technologies hereby disclaims any and all warranties and liabilities of any kind, including without limitation warranties of non-infringement of intellectual property rights of any third party.

In addition, any information given in this document is subject to customer's compliance with its obligations stated in this document and any applicable legal requirements, norms and standards concerning customer's products and any use of the product of Infineon Technologies in customer's applications.

The data contained in this document is exclusively intended for technically trained staff. It is the responsibility of customer's technical departments to evaluate the suitability of the product for the intended application and the completeness of the product information given in this document with respect to such application.

For further information on the product, technology, delivery terms and conditions and prices please contact your nearest Infineon Technologies office (www.infineon.com).

WARNINGS

Due to technical requirements products may contain dangerous substances. For information on the types in question please contact your nearest Infineon Technologies office.

Except as otherwise explicitly approved by Infineon Technologies in a written document signed by authorized representatives of Infineon Technologies, Infineon Technologies' products may not be used in any applications where a failure of the product or any consequences of the use thereof can reasonably be expected to result in personal injury.